

## AE3 EV Fuse



### FEATURES:

- 800 VDC automotive fuse
- Rated Current: 8-50 A
- Rated Breaking Capacity: 20 kA
- Time Constant: 1-3 ms
- Dimensions: 10x38 mm
- General purpose fuse for EV/HEV auxiliary protection
- Ref. to ISO 8820-8; GB/T 31465.6
- Recommended fuse holder: BH114

### ELECTRICAL SPECIFICATIONS

Part Number / Configurations				Rated Current	Ampere Code	Rated Voltage	Breaking Capacity
Cylindrical	Central Mount	Level Mount	PCB Mount				
AE31800i07	AE31800i04	AE31800i05	AE31800i06	8A	1800	800 VDC	20 kA@700 VDC 10 kA@750 VDC 10 kA@800 VDC
AE32100i07	AE32100i04	AE32100i05	AE32100i06	10A	2100		
AE32150i07	AE32150i04	AE32150i05	AE32150i06	15A	2150		
AE32200i07	AE32200i04	AE32200i05	AE32200i06	20A	2200		
AE32250i07	AE32250i04	AE32250i05	AE32250i06	25A	2250		
AE32300i07	AE32300i04	AE32300i05	AE32300i06	30A	2300		
AE32350i07	AE32350i04	AE32350i05	AE32350i06	35A	2350		
AE32400i07	AE32400i04	AE32400i05	AE32400i06	40A	2400		
AE32500i07	AE32500i04	AE32500i05	AE32500i06	50A	2500		

### TIME VS CURRENT CHARACTERISTIC

Rated Current	110%	135%	150%	200%	300%	500%
8-50 A	>4 h	150s - 1h	10-1000 s	0.5-100 s	0.1-15s	0.05-1 s

### PART NUMBER SYSTEM

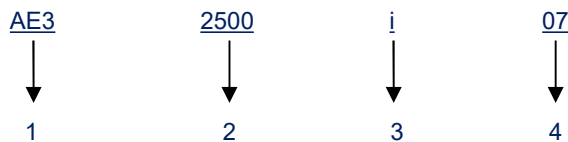

- 1 .....Product Series ..... AE3
- 2 ..... Ampere Code ..... 50 A (see ampere code column of electrical specifications)
- 3 ..... Rated Voltage ..... i - 800 V
- 4 ..... Supplementary Code ..... 07: Cylindrical; 04: Central Mount; 05: Level Mount; 06: PCB Mount

**DIMENSIONS (mm)**

AE3xxxxi07

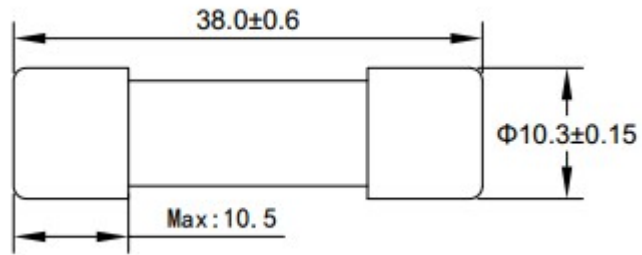

AE3xxxxi04

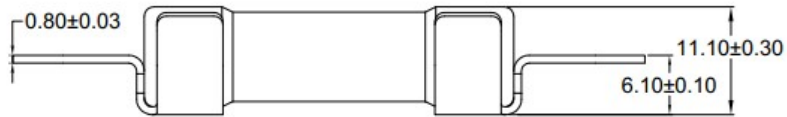
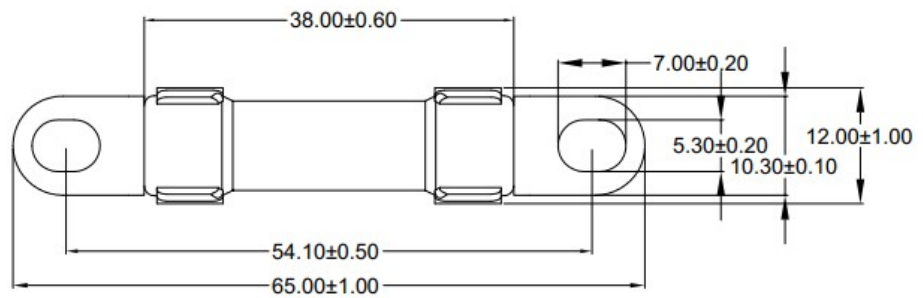

AE3xxxxi05

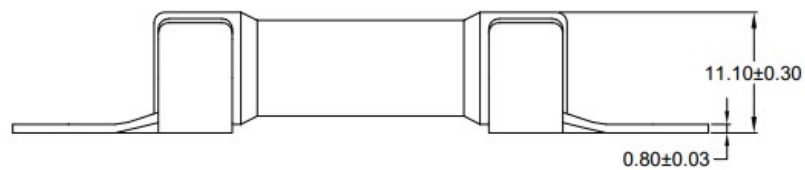
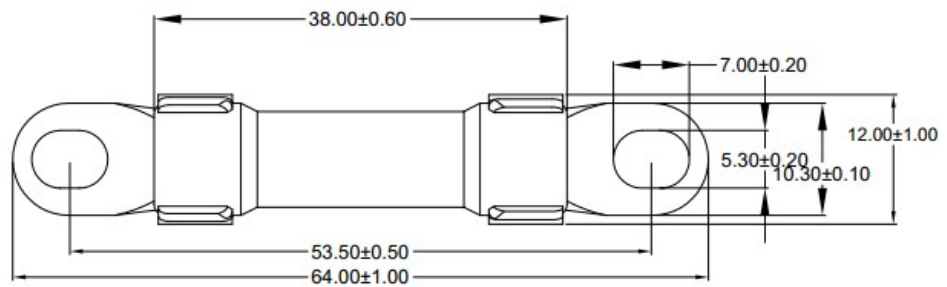

AE3xxxxi06

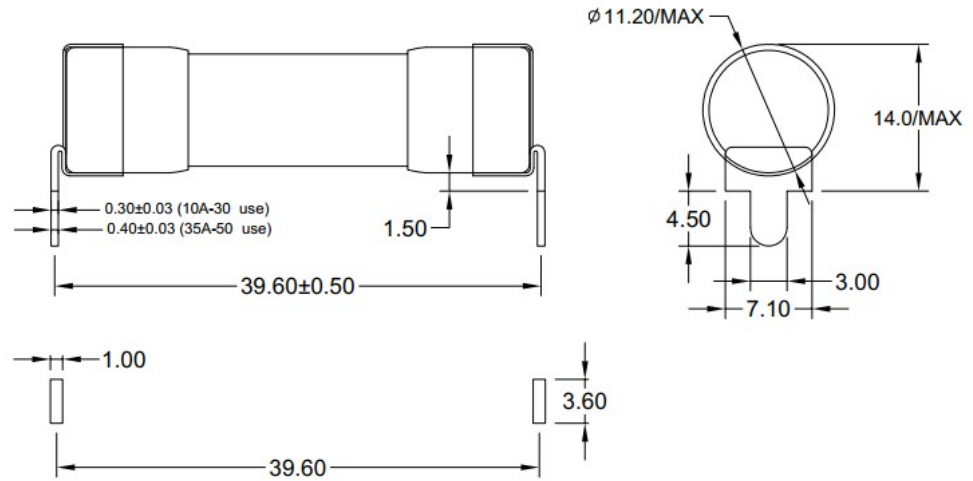

### TIME CURRENT CURVE

